



- Six foot (1.8 m), six port antenna with a 33° azimuth beamwidth covering 698-894 MHz and 1710-2360 MHz
- Four high band and two low band ports including the WCS band in a single antenna
- Sharp elevation beamwidth aides in network planning
- Optimal elevation sidelobe performance
- Enhanced array spacing ensures optimal MIMO performance
- Exceeds minimum PIM performance requirements
- Multi-network solution in one radome with six ports
- Reduces tower load and increases space for tower mounted remote radio heads
- Multi-band design improves site radio resource management
- Field replaceable, integrated AISG 2.0 compliant Remote Electrical Tilt (RET) system with independent tilt control for each paired port

Overview

The CCI HexPort multi-band array is a six port antenna with full Wireless Communication Service 2305-2360 MHz (WCS) band coverage. With four high band ports covering 1710-2360 MHz and two low band ports covering 698-894 MHz, this six foot (1.8 m) CCI HexPort provides the capability to deploy 4x4 Multiple-input Multiple-output (MIMO) in the high band. The HexPort allows separate tilt control for each pair of ports enabling maximum flexibility in network deployment.

CCI has engineered its antennas using new and innovative design techniques to provide optimal sidelobe performance, sharp elevation beams, and high front to back ratio.

Multiple technologies can now be connected to a single antenna, reducing tower load, lease expense, deployment time and installation cost.

CCI antennas are designed and produced to ISO 9001 certification standards for reliability and quality in our state-of-the-art manufacturing facilities.

Applications

- 4x4 MIMO for the high band and 2x2 MIMO for the low band
- Increase capacity without adding antennas
- Deploy WCS band without increasing antenna count
- High sector count sites
- Densely populated macro sites
- Cosite current, and next-generation basestation technologies on the same antenna



HexPort Multi-Band Antenna

HPA-33R-BUU-H6

SPECIFICATIONS

Electrical

Ports	2 x Low Band Ports for 698-894 MHz		4 x High Band Ports for 1710-2360 MHz			
Frequency Range	698-806 MHz	824-894 MHz	1850-1990 MHz	1710-1780/2110-2180 MHz	2305-2360 MHz	
Gain	16.5 dBi	17.6 dBi	19.0 dBi	18.4 dBi	19.5 dBi	20.1 dBi
Azimuth Beamwidth (-3dB)	38°	33°	33°	36°	30°	28°
Elevation Beamwidth (-3dB)	12.0°	10.8°	6.9°	7.5°	6.0°	5.3°
Electrical Downtilt	0° to 10°	0° to 10°	0° to 8°	0° to 8°	0° to 8°	0° to 8°
Elevation Sidelobes (1st Upper)	< -18 dB	< -18 dB	< -18 dB	< -18 dB	< -18 dB	< -16 dB
Front-to-Back Ratio @180°	> 30 dB	> 30 dB	> 35 dB	> 35 dB	> 35 dB	> 35 dB
Front-to-Back Ratio over ± 20°	> 30 dB	> 30 dB	> 30 dB	> 30 dB	> 30 dB	> 30 dB
Cross-Polar Discrimination (at Peak)	> 25 dB	> 25 dB	> 25 dB	> 25 dB	> 22 dB	> 22 dB
Cross-Polar Discrimination (at ± 30°)	> 22 dB	> 22 dB	> 22 dB	> 22 dB	> 19 dB	> 22 dB
Cross-Polar Port-to-Port Isolation	> 25 dB	> 25 dB	> 25 dB	> 25 dB	> 25 dB	> 25 dB
Voltage Standing Wave Ratio (VSWR)	< 1.5:1	< 1.5:1	< 1.5:1	< 1.5:1	< 1.5:1	< 1.5:1
Passive Intermodulation (2x20W)	≤ -150 dBc	≤ -150 dBc	≤ -150 dBc	≤ -150 dBc	≤ -150 dBc	≤ -150 dBc
Input Power Continuous Wave (CW)	500 watts	500 watts	300 watts	300 watts	300 watts	300 watts
Polarization	Dual Pol 45°	Dual Pol 45°	Dual Pol 45°	Dual Pol 45°	Dual Pol 45°	Dual Pol 45°
Input Impedance	50 ohms	50 ohms	50 ohms	50 ohms	50 ohms	50 ohms
Lightning Protection	DC Ground	DC Ground	DC Ground	DC Ground	DC Ground	DC Ground

Mechanical

Dimensions (LxWxD)	72.5x23.1x8.8 in (1841x587x224 mm)
Survival Wind Speed	> 125 mph (> 201 kph)
Front Wind Load	366 lbs (1627 N) @ 100 mph (161 kph)
Side Wind Load	164 lbs (728 N) @ 100 mph (161 kph)
Equivalent Flat Plate Area	14.3 ft ² (1.3 m ²)
Weight *	66.6 lbs (30.2 kg)
RET System Weight	5.0 lbs (2.3 kg)
Connector	6 x 7-16 DIN female long neck
Mounting Pole	2 to 5 in (5 to 12 cm)

* Weight excludes mounting and RET

Bottom View

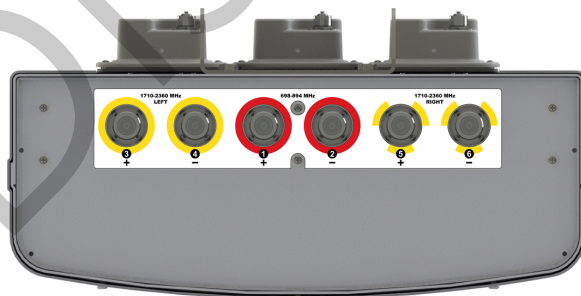

RET Connection Diagram

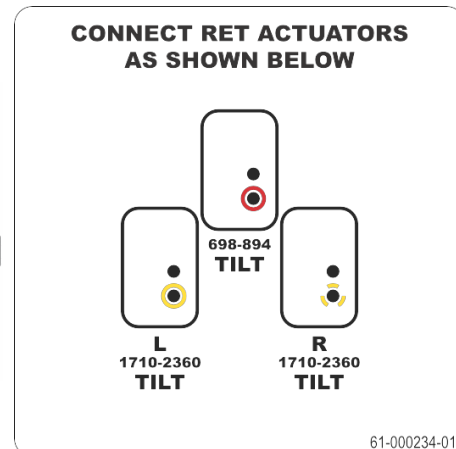

61-000234-01



Mechanical

Connector Spacing

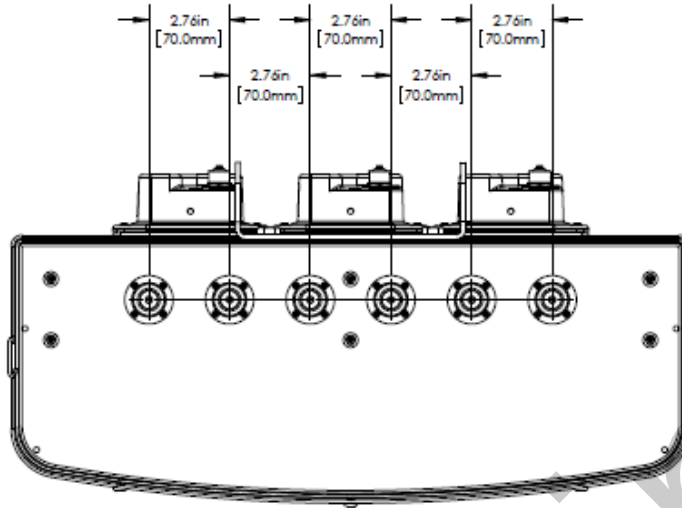

Discontinued



SPECIFICATIONS

HexPort Multi-Band Antenna

HPA-33R-BUU-H6

Typical Antenna Patterns

For detailed information on additional antenna patterns, contact customer support at support@cciproducts.com

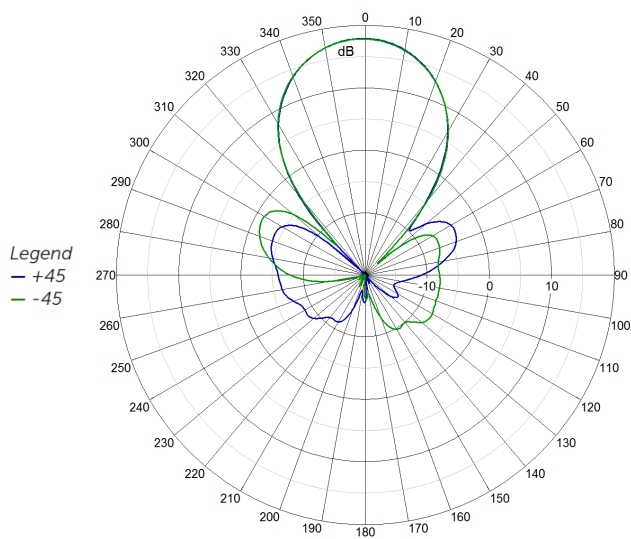

875 MHz Azimuth

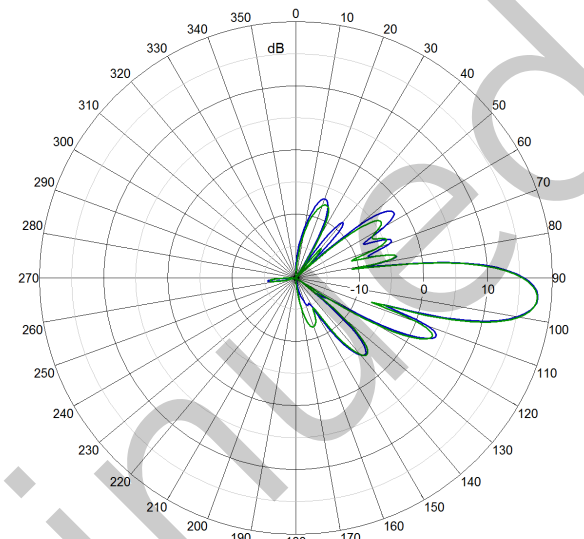

875 MHz Elevation 5°

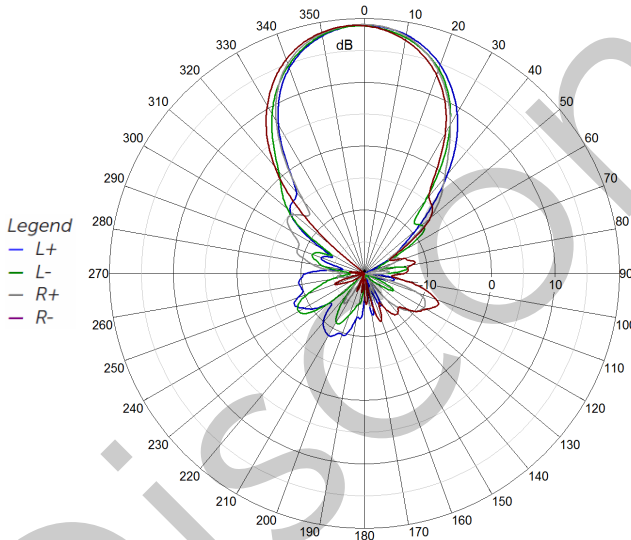

1940 MHz Azimuth

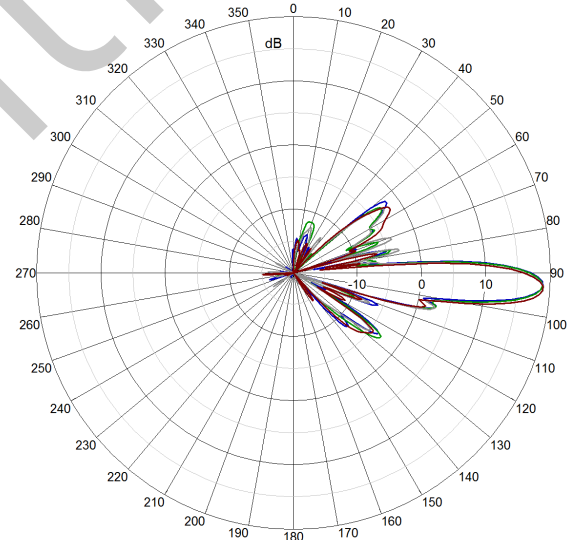

1940 MHz Elevation 4°



ORDERING

HexPort Multi-Band Antenna

HPA-33R-BUU-H6

Parts & Accessories

HPA-33R-BUU-H6	Six foot (1.8 m) HexPort antenna with 33° azimuth beamwidth and 3 factory installed BSA-RET200 RET actuators
HPA-33R-BUU-H6-K	Antenna kit with 3 factory installed RET actuators and MBK-01 mounting bracket
MBK-01	Mounting bracket kit (top and bottom) with 0° to 10° mechanical tilt adjustment
BSA-RET200	Remote electrical tilt actuator
HPA-CBK-AG-RRU	HexPort antenna to RRU AISG cable kit
HPA-CBK-RA-AG-RRU	HexPort antenna to RRU AISG right angle cable kit

Discontinued



Mounting Bracket Kit

MBK-01

Mechanical

Weight	12.6 lbs (5.7 kg)
Hinge Pitch	47.25 in (1200 mm)
Mounting Pole Dimension	2 to 5 in (5 to 12 cm)
Fastener Size	M12
Installation Torque	40 ft·lb (54 N·m)
Mechanical Tilt Adjustment	0° - 10°

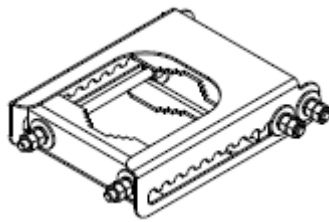

MBK-01 Top Adjustable Bracket

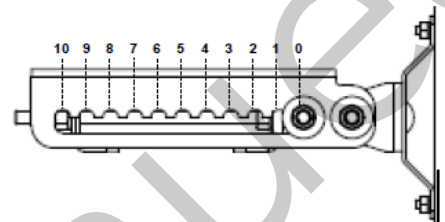

MBK-01 Top Adjustable Bracket Side View

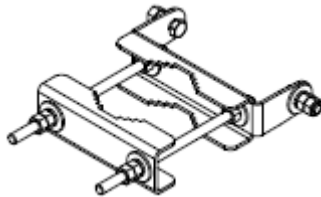

MBK-01 Bottom Fixed Bracket

Discontinued



Remote Electrical Tilt Actuator (RET)

BSA-RET200

General Specifications

Part Number	BSA-RET200
Protocols	AISG 2.0
RET Type	Type 1
Adjustment Cycles	>10,000 cycles
Tilt Accuracy	±0.1°
Temperature Range	-40° C to 70° C

Electrical

Data Interface Signal	DC
Input Voltage	10-30 Vdc
Current Consumption Tilt	120 mA at $V_{in}=24$
Current Consumption Idle	55 mA at $V_{in}=24$
Hardware Interface	AISG-RS 485 A/B
Input Connector	Male 1 × 8 pin Daisy Chain
Output Connector	Female 1 × 8 pin Daisy Chain

Mechanical

Dimensions (LxWxD)	8.0x5.0x2.0 in. (213x135x51 mm)
Housing	ASA/ABS/Aluminum
Weight	1.7 lbs (0.75 kg)

ASA= Acrylic Styrene Acrylonitrile
ABS=Acrylonitrile Butadiene Styrene

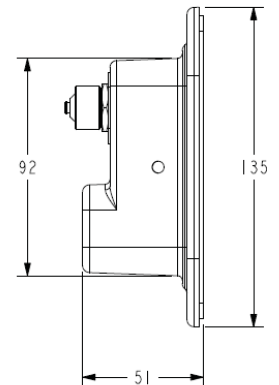
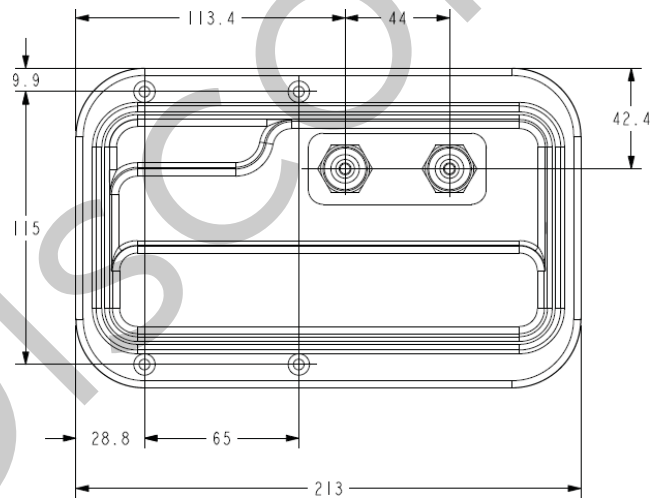



Electrical Specifications

Individual Cable Part Number	AISGC-M-F-18	AISGC-M-F-10FT
Cable style	UL2464	UL2464
Protocol	AISG 1.1 and AISG 2.0	AISG 1.1 and AISG 2.0
Maximum voltage	300 V	300 V
Rated current	5 A at 104° F (40° C)	5 A at 104° F (40° C)

Mechanical Specifications

Individual Cable Part Number	AISGC-M-F-18	AISGC-M-F-10FT
Cables per kit	2	2
Connectors	2 x 8 pin IEC 60130-9 Straight male/straight female	2 x 8 pin IEC 60130-9 Straight male/straight female
Tightening torque	Hand tighten only ≈ 1.84 ft-lbs (2.5 N-m)	Hand tighten only ≈ 1.84 ft-lbs (2.5 N-m)
Construction	Shielded (Tinned Copper Braid)	Shielded (Tinned Copper Braid)
Braid coverage	85%	85%
Jacket Material	Matte Polyurethane (Black)	Matte Polyurethane (Black)
Conductors	1 twisted pair - 24 AWG 3 conductors - 19 AWG AWM style 2464	1 twisted pair - 24 AWG 3 conductors - 19 AWG AWM style 2464
Cable Diameter	0.307 in (7.8 mm)	0.307 in (7.8 mm)
Length	18 - 20 in (457 - 508 mm)	120 in (3048 mm)
Weight	0.27 lbs (0.12 kg)	0.69 lbs (.31 kg)
Minimum bend radius	3.9 in (100 mm)	3.9 in (100 mm)

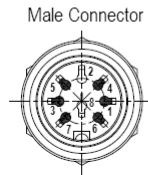
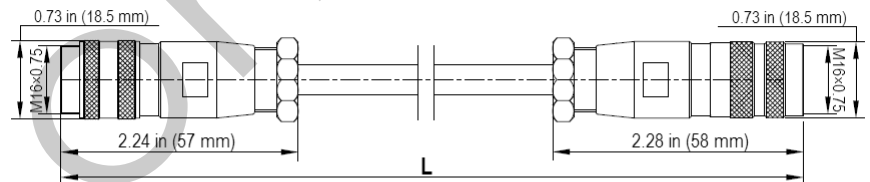

AISG 2.0 Pin Assignments	AISG Standard
1	+12 V DC nominal (optional)
2	No conductor
3	RS485 B
4	RS 485 Ground
5	RS485 A
6	10 - 30 V DC
7	DC Return (not DC power ground)
8	No conductor

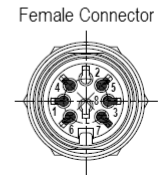

AISG-Male to AISG-Female Jumper Cable

Environmental Specifications

Individual Cable Part Number	AISGC-M-F-18	AISGC-M-F-10FT
Temperature Range	-40° to 80° C	-40° to 80° C
Flammability	UL 1581 VW-1	UL 1581 VW-1
Ingress Protection	IEC 60529:2001, IP67	IEC 60529:2001, IP67

Electrical/Mechanical/Environmental Specifications

	RET to RET Cables	RRU to Antenna Cables
Individual Cable Part Number	AISGC-MRA-FRA-20	AISGC-M-FRA-10FT
Cable style	UL2464	
Protocol	AISG 1.1 and AISG 2.0	
Maximum voltage	300 V	
Rated current	5 A at 104° F (40° C)	
Temperature Range	-40° to 80° C	
Flammability	UL 1581 VW-1	
Ingress Protection	IEC 60529:2001, IP67	
Tightening torque	Hand tighten only ≈ 1.84 ft-lbs (2.5 N·m)	
Construction	Shielded (Tinned Copper Braid)	
Braid coverage	85%	
Jacket Material	Matte Polyurethane (Black)	
Conductors	1 twisted pair - 24 AWG 3 conductors - 19 AWG AWM style 2464	
Cable Diameter	0.307 in (7.8 mm)	
Minimum bend radius	3.9 in (100 mm)	
Connectors	2 x 8 pin IEC 60130-9 Right angle male/right angle female	2 x 8 pin IEC 60130-9 Straight male/right angle female
Length	20 in (508 mm)	120 in (3048 mm)
Weight	0.23 lbs (0.10 kg)	0.77 lbs (0.35 kg)
Cables per kit	2	2

Mechanical Specifications

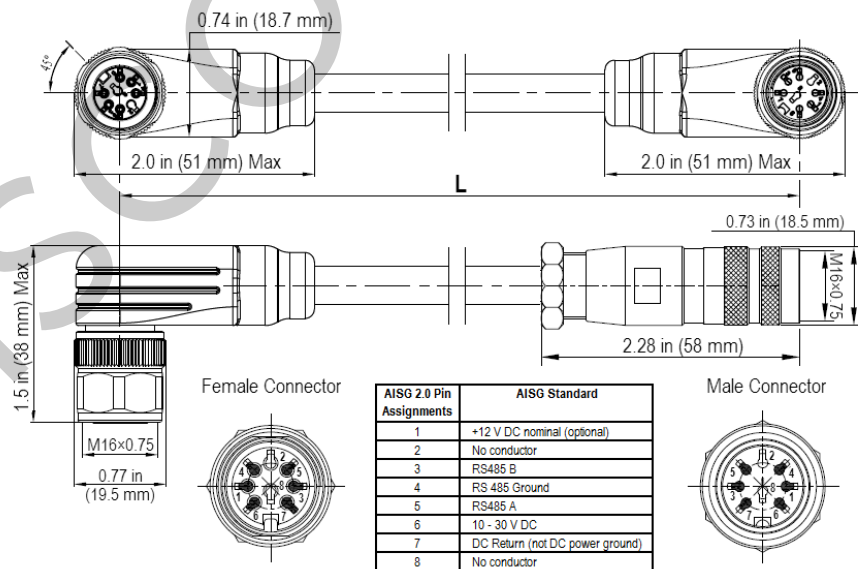

Right Angle to Right Angle and Right Angle to Straight Jumper Cable



STANDARDS & CERTIFICATIONS

HexPort Multi-Band Antenna

HPA-33R-BUU-H6

Standards & Compliance

Safety	EN 60950-1, UL 60950-1
Emission	EN 55022
Immunity	EN 55024
Environmental	IEC 60068-2-1, IEC 60068-2-2, IEC 60068-2-5, IEC 60068-2-6, IEC-60068-2-11, IEC 60068-2-14, IEC 60068-2-18, IEC 60068-2-27, IEC 60068-2-29, IEC 60068-02-30, IEC 60068-2-52, IEC 60068-2-64, GR-63-CORE 4.3.1, EN 60529, IP 24

Certifications

Antenna Interface Standards Group (AISG), Federal Communication Commission (FCC) Part 15 Class B, CE, CSA US, ISO 9001



DISCONTINUED

