



- Eight foot (2.4 m), six port antenna with a 65° azimuth beamwidth covering 698-896 MHz and 1695-2180 MHz
- Four high band and two low band ports in a single antenna
- Sharp elevation beamwidth aids in network planning
- Optimal elevation sidelobe performance
- Enhanced array spacing ensures optimal MIMO performance
- Exceeds minimum PIM performance requirements
- Multi-network solution in one radome with six ports
- Reduces tower load and increases space for tower mounted remote radio heads
- Multi-band design improves site radio resource management
- Field replaceable, integrated AISG 2.0 compliant Remote Electrical Tilt (RET) system with independent tilt control for each paired port

Overview

The CCI HexPort multi-band array is a six port antenna with full Advanced Wireless Service (AWS) band coverage. With four high band ports covering 1695-2180 MHz and two low band ports covering 698-896 MHz, this eight foot (2.4 m) CCI HexPort provides the capability to deploy 4x4 Multiple-input Multiple-output (MIMO) in the high band. CCI has engineered its antennas using new and innovative design techniques to provide optimal sidelobe performance, sharp elevation beams, and high front to back ratio.

Multiple technologies can now be connected to a single antenna, reducing tower load, lease expense, deployment time and installation cost.

CCI antennas are designed and produced to ISO 9001 certification standards for reliability and quality in our state-of-the-art manufacturing facilities.

Applications

- 4x4 MIMO for the high band and 2x2 MIMO for the low band
- Increase capacity without adding antennas
- Cosite current, and next-generation basestation technologies on the same antenna



HexPort Multi-Band Antenna

HPA-65I-BWW-H8

SPECIFICATIONS

Electrical

Ports	2 × Low Band Ports for 698-896 MHz		4 × High Band Ports for 1695-2180 MHz		
Frequency Range	698-806 MHz	824-896 MHz	1850-1990 MHz	1695-1755/2110-2180 MHz	
Gain (dBi)	15.3	16.2	17.0	16.4	17.5
Azimuth Beamwidth (-3dB) (°)	65	61	62	67	64
Elevation Beamwidth (-3dB) (°)	10.0	8.4	5.6	6.2	5.1
Electrical Downtilt (°)	2 to 10	2 to 10	0 to 8	0 to 8	0 to 8
Elevation Sidelobes (1st Upper)(dB)	< -17	< -17	< -24	< -22	< -24
Front-to-Back Ratio @180° (dB)	> 25	> 25	> 30	> 30	> 30
Cross-Polar Discrimination (at Peak)(dB)	> 22	> 20	> 25	> 25	> 25
Cross-Polar Port-to-Port Isolation (dB)	> 25	> 25	> 25	> 25	> 25
Voltage Standing Wave Ratio (VSWR)	< 1.5:1	< 1.5:1	< 1.5:1	< 1.5:1	< 1.5:1
Passive Intermodulation (2x20W)(dBc)	≤ -153	≤ -153	≤ -153	≤ -153	≤ -153
Input Power Continuous Wave (CW)	500 watts	500 watts	300 watts	300 watts	300 watts
Polarization	Dual Pol 45°	Dual Pol 45°	Dual Pol 45°	Dual Pol 45°	Dual Pol 45°
Input Impedance	50 ohms	50 ohms	50 ohms	50 ohms	50 ohms
Lightning Protection	DC Ground	DC Ground	DC Ground	DC Ground	DC Ground

BASTA Electrical Specifications*

	698-806 MHz	824-896 MHz	1850-1990 MHz	1695-1755/2110-2180 MHz	
Frequency Range	698-806 MHz	824-896 MHz	1850-1990 MHz	1695-1755/2110-2180 MHz	
Gain over all Tilts (dBi)	15.3	16.2	17.0	16.4	17.5
Gain over all Tilts Tolerance (dB)	0.6	0.5	0.3	0.2	0.3
Gain at Low-tilt (dBi)	15.5	16.3	16.9	16.5	17.5
Gain at Mid-tilt (dBi)	15.4	16.3	17.1	16.5	17.6
Gain at High-tilt (dBi)	15.2	16.1	17.1	16.4	17.4
Azimuth Beamwidth Tolerance (°)	2.0	3.6	2.5	2.9	4.2
Elevation Beamwidth Tolerance (°)	1.1	0.5	0.3	0.2	0.2
Electrical Downtilt Deviation (°)	1.0	1.0	1.0	0.9	0.9
Front-to-Back Ratio over ± 20° (dB)	21.5	20.6	21.9	21.2	22.2
First Upper Sidelobe Suppression (dB)	16.0	16.8	22.0	19.7	21.5
Upper Sidelobe Suppression peak to 20°(dB)	17.2	16.5	19.7	19.1	19.7

* Electrical specifications follow document "Recommendation on Base Station Antenna Standards" (BASTA) V9.6.
All specifications are subject to change without notice.

Mechanical

Dimensions (LxWxD)	92.8x14.4x7.3 in (2358x366x185 mm)
Survival Wind Speed	> 150 mph (> 241 kph)
Front Wind Load	327 lbs (1455 N) @ 100 mph (161 kph)
Side Wind Load	191 lbs (849 N) @ 100 mph (161 kph)
Equivalent Flat Plate Area	12.8 ft ² (1.2 m ²)
Weight *	58.2 lbs (26.4 kg)
Connector	6 × 7-16 DIN female long neck
Mounting Pole	2 to 5 in (5 to 12 cm)

* Weight excludes mounting

HexPort Multi-Band Antenna

HPA-65I-BWW-H8

SPECIFICATIONS

Mechanical

Bottom View

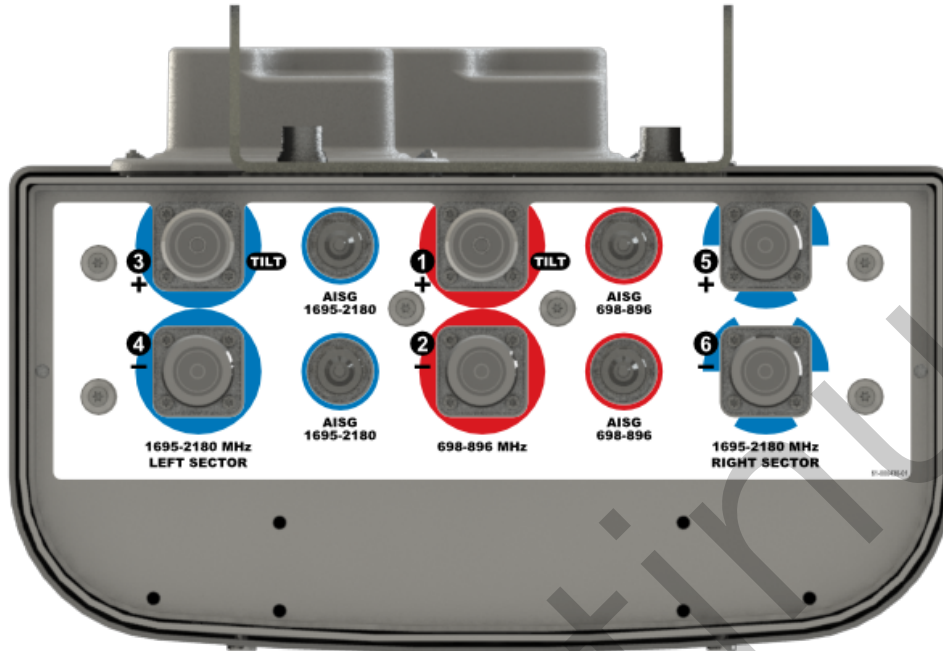

Connector Spacing

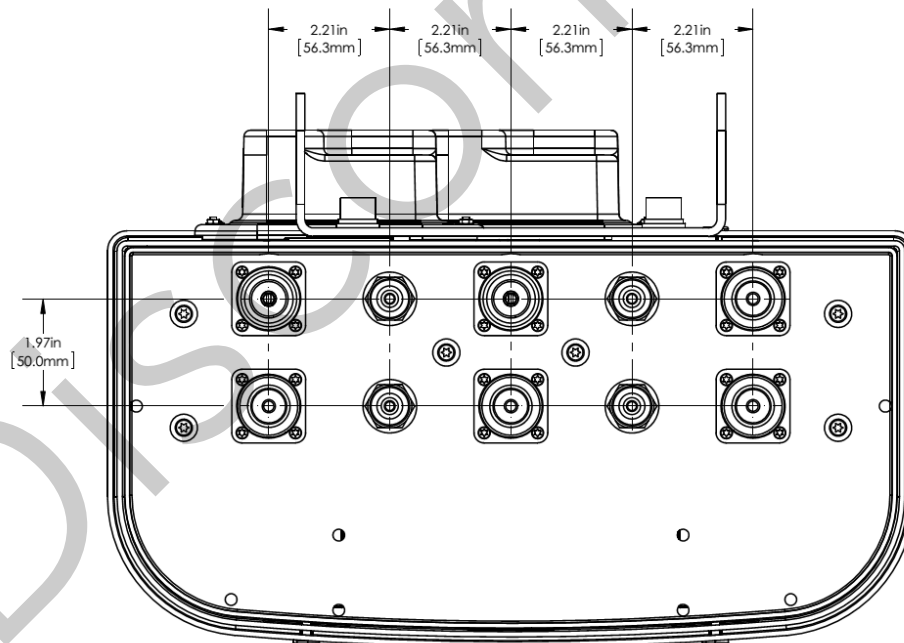



Typical Antenna Patterns

For detailed information on additional antenna patterns, contact customer support at support@cciproducts.com

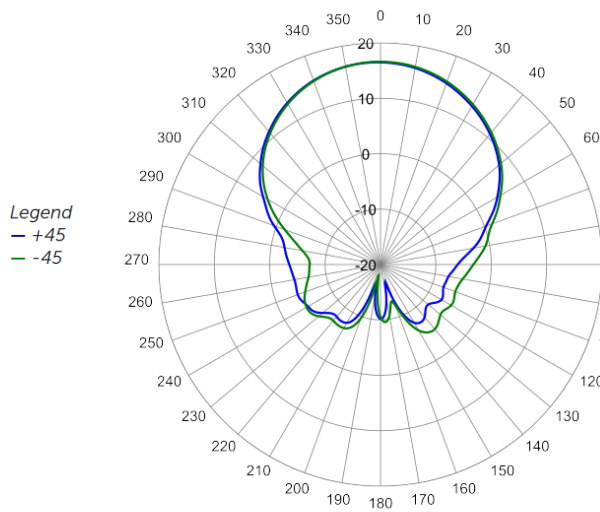

894 MHz Azimuth

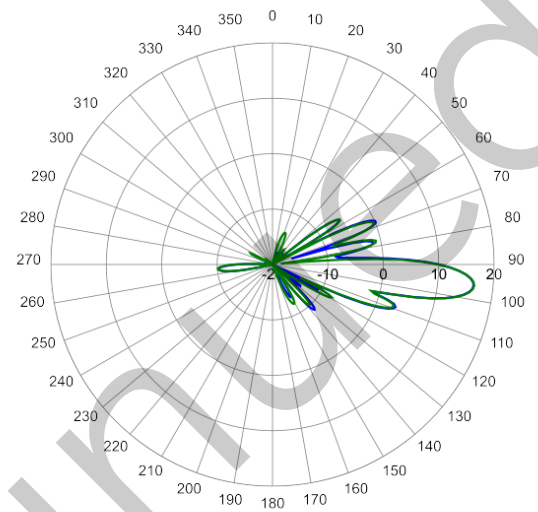

894 MHz Elevation 6°

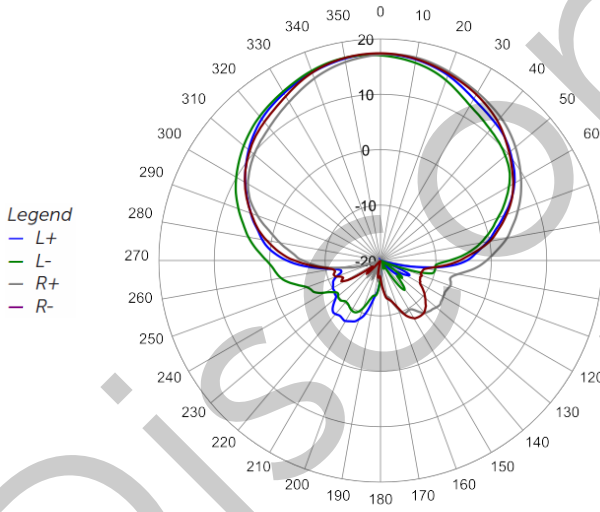

1930 MHz Azimuth

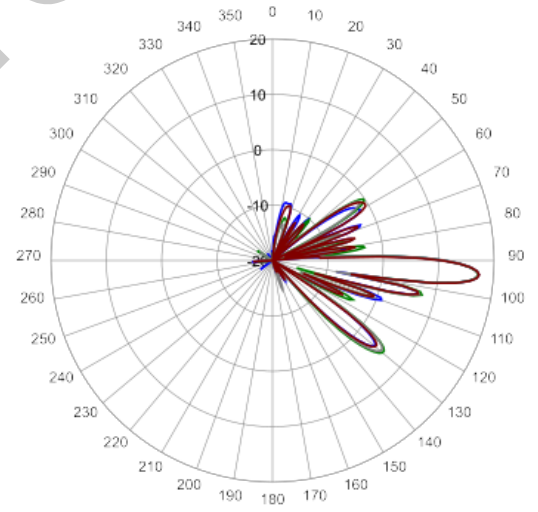

1930 MHz Elevation 4°



ORDERING

HexPort Multi-Band Antenna

HPA-65I-BWW-H8

Parts & Accessories

HPA-65I-BWW-H8	Eight foot (2.4 m) HexPort antenna with 65° azimuth beamwidth and 2 factory installed BSA-RET400 RET actuators, and MBK-01 mounting bracket
MBK-01	Mounting bracket kit (top and bottom) with 0° to 10° mechanical tilt adjustment
TM-01	Optional triple mount mast bracket for mounting up to three 65° antennas on a pole (or mast).
BSA-RET400	Remote electrical tilt actuator

Discontinued



Mounting Bracket Kit

MBK-01

Mechanical

Weight	12.6 lbs (5.7 kg)
Hinge Pitch	47.25 in (1200 mm)
Mounting Pole Dimension	2 to 5 in (5 to 12 cm)
Fastener Size	M12
Installation Torque	40 ft·lb (54 N·m)
Mechanical Tilt Adjustment	0° - 10°

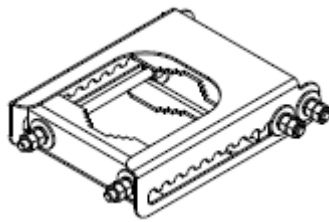

MBK-01 Top Adjustable Bracket

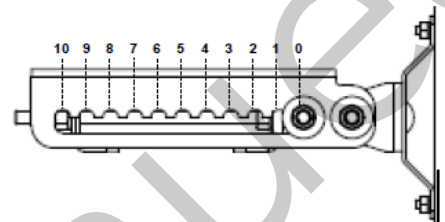

MBK-01 Top Adjustable Bracket Side View

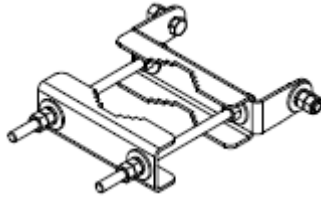

MBK-01 Bottom Fixed Bracket

Discontinued



Triple Mount Cluster Bracket

TM-01

Mechanical

Weight	21.6 lbs (9.8 kg)
Fastener Size	M10
Installation Torque	40 ft-lb (54 N-m)
Hinge Pitch (Vertical)	13.0 in (330 mm) or 31.5 in (800 mm) or 47.2 in (1200 mm)
Mechanical Tilt Adjustment	None

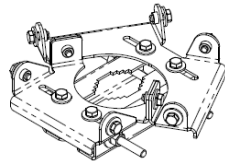

TM-01 Bracket

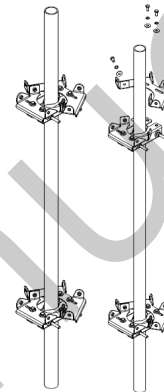

TM-01 Mounting Brackets (on Pole)

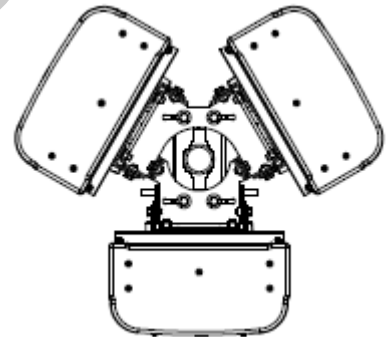
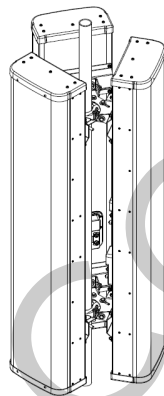

3 - 65° Antennas Mounted on Pole using TM-01 Brackets (Iso and Top Views)



Internal Remote Electrical Tilt (iRET)

BSA-RET400

General Specifications

Part Number	BSA-RET400
Protocols	AISG 2.0
RET Type	Type 17
Adjustment Cycles	>10,000 cycles
Tilt Accuracy	±0.1°
Temperature Range	-40° C to 70° C

Electrical

Data Interface Signal	DC
Input Voltage	10-30 Vdc
Current Consumption Tilt	100 mA at $V_{in}=24$ (500 mA MAX)
Current Consumption Idle	10 mA at $V_{in}=24$

Mechanical

Dimensions (LxWxD)	7.0x5.3x1.8 in. (179x134x45 mm)
Housing	ASA/ABS/Aluminum
Weight	1.3 lbs (0.6 kg)

ASA= Acrylic Styrene Acrylonitrile
ABS=Acrylonitrile Butadiene Styrene

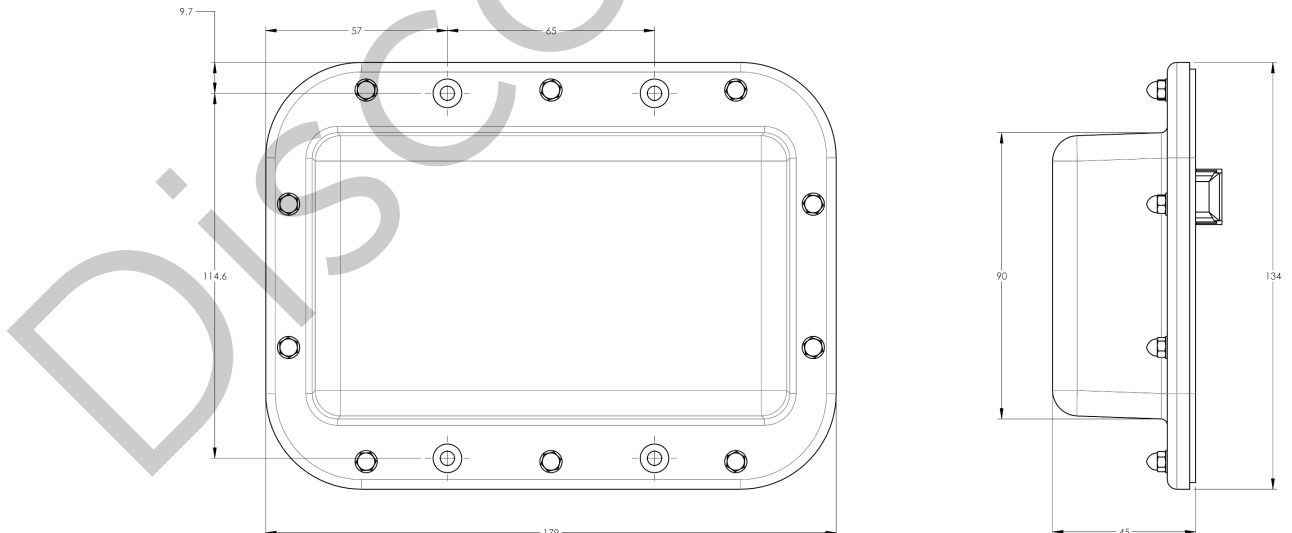



STANDARDS & CERTIFICATIONS

HexPort Multi-Band Antenna

HPA-65I-BWW-H8

Standards & Compliance

Safety	EN 60950-1, UL 60950-1
Emission	EN 55022
Immunity	EN 55024
Environmental	IEC 60068-2-1, IEC 60068-2-2, IEC 60068-2-5, IEC 60068-2-6, IEC-60068-2-11, IEC 60068-2-14, IEC 60068-2-18, IEC 60068-2-27, IEC 60068-2-29, IEC 60068-02-30, IEC 60068-2-52, IEC 60068-2-64, GR-63-CORE 4.3.1, EN 60529, IP 24

Certifications

Antenna Interface Standards Group (AISG), Federal Communication Commission (FCC) Part 15 Class B, CE, CSA US, ISO 9001



DISCONTINUED

