



Antennas

DATA SHEET

Multi-band Bi-Sector™ Array

BSA-M65R-BU-H4

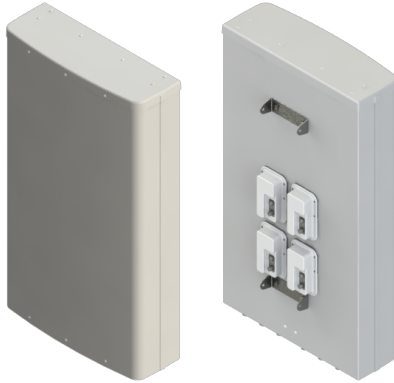

- Four foot (1.3 m), eight port, dual beam antenna with patented asymmetrical beam shapes optimized for LTE
- Two independent 33° beams to match existing 65° patterns, covering 698-894 MHz and 1710-2360 MHz
- Two pairs (one low band and one high band) of +45° and -45° cross-polarized ports for each beam
- Provides full 2x2 MIMO performance in both bands
- Field replaceable, integrated AISG 2.0 compliant Remote Electrical Tilt (RET) system with independent tilt control for the high and low band in each 33° sector
- Dramatic increase in site capacity through higher order sectorization which offsets the need to build new sites
- Boosts data throughput by minimizing interference and optimizing coverage
- Sharp elevation beamwidth aides in network planning
- Optimal elevation sidelobe performance
- Exceeds minimum PIM performance requirements

Overview

The CCI multi-band Twin HexPort Bi-Sector™ array is a dual beam antenna with full 700 MHz, SMR 800, Cellular, AWS, PCS and WCS band coverage. This four foot (1.3 m) antenna can be configured to deploy two asymmetric 33° beams each containing two low band ports covering 698-894 MHz and two high band ports covering 1710-2360 MHz in a single enclosure. The Remote Electrical Tilt (RET) feature allows separate tilt control for the high and low band in each 33° beam, enabling maximum flexibility in network deployment.

CCI's unique patented bi-sector technology provides optimized overlap between the pairs of asymmetric beams, lowers soft handover losses in LTE, UMTS/HSPA+ and CDMA/EVDO systems, while minimizing interference between sectors. Fast roll-off of each of the outer beams and high front-to-back ratios ensure reduced interference. This patented approach enhances data transfer rates within LTE, UMTS and EVDO network sectors and addresses "hotspots" in mobile wireless operator networks.

The single panel design of the Bi-Sector™ Array offers the opportunity to reduce antenna count and directly replaces an existing 65° antenna without mount changes and avoids costly leasing and zoning changes. The enhanced coverage matches the existing sector footprint and minimizes the need for optimization and adjacent site changes, providing operators with significant CAPEX and OPEX cost savings.

CCI antennas are designed and produced to ISO 9001 certification standards for reliability and quality in our state-of-the-art manufacturing facilities.

Applications

- Delivers increased capacity and data-throughput for sites that are performance or capacity constrained
- Increase capacity without the need for new site builds or carrier adds and without using valuable spectrum resources
- Two Sectors 2x2 MIMO for the high band and 2x2 MIMO for the low band



Antennas

Multi-band Bi-Sector™ Array

BSA-M65R-BU-H4

SPECIFICATIONS

Electrical

Ports	4 × Low Band Ports for 698-896 MHz			4 × High Band Ports for 1710-2360 MHz		
Frequency Range	698-806 MHz	824-896 MHz	1850-1990 MHz	1710-1780/2110-2180 MHz	2305-2360 MHz	
Gain	15.1 dBi	16.1 dBi	17.3 dBi	16.7 dBi	17.9 dBi	17.8 dBi
Azimuth Beamwidth (-3dB)	35°	32°	31°	35°	28°	25°
Elevation Beamwidth (-3dB)	16.5°	14.5°	8.1°	9.0°	7.3°	6.8°
Electrical Downtilt	2° to 14°	2° to 14°	0° to 9°	0° to 9°	0° to 9°	0° to 9°
Elevation Sidelobes (1st Upper)	< -17 dB	< -17 dB	< -18 dB	< -18 dB	< -18 dB	< -18 dB
Front-to-Back Ratio @180°	> 30 dB	> 35 dB	> 30 dB	> 35 dB	> 35 dB	> 35 dB
Front-to-Back Ratio over ± 20°	> 25 dB	> 25 dB	> 25 dB	> 25 dB	> 25 dB	> 25 dB
Cross-Polar Port-to-Port Isolation	> 25 dB	> 25 dB	> 25 dB	> 25 dB	> 25 dB	> 25 dB
Voltage Standing Wave Ratio(VSWR)	< 1.5:1	< 1.5:1	< 1.5:1	< 1.5:1	< 1.5:1	< 1.5:1
Passive Intermodulation (2x20W)	≤ -150 dBc	≤ -150 dBc	≤ -150 dBc	≤ -150 dBc	≤ -150 dBc	≤ -150 dBc
Input Power Continuous Wave (CW)	500 watts	500 watts	300 watts	300 watts	300 watts	300 watts
Polarization	Dual Linear 45°	Dual Linear 45°	Dual Linear 45°	Dual Linear 45°	Dual Linear 45°	Dual Linear 45°
Input Impedance	50 ohms	50 ohms	50 ohms	50 ohms	50 ohms	50 ohms
Lightning Protection	DC Ground	DC Ground	DC Ground	DC Ground	DC Ground	DC Ground

Mechanical

Dimensions (LxWxD)	49.9x28.5x9.7 in (1267x723x245 mm)
Survival Wind Speed	> 150 mph (> 240 kph)
Front Wind Load	303 lbs (1348 N) @ 100 mph (161 kph)
Side Wind Load	113 lbs (502 N) @ 100 mph (161 kph)
Equivalent Flat Plate Area	11.8 ft² (1.1 m²)
Weight *	66.1 lbs (30.0 kg)
RET System Weight	6.6 lbs (3.0 kg)
Connector	8 × 7-16 DIN female long neck
Mounting Pole	2 to 5 in (5 to 12 cm)

* Weight excludes mounting and RET



Antennas

Multi-band Bi-Sector™ Array

BSA-M65R-BU-H4

SPECIFICATIONS

Bottom View

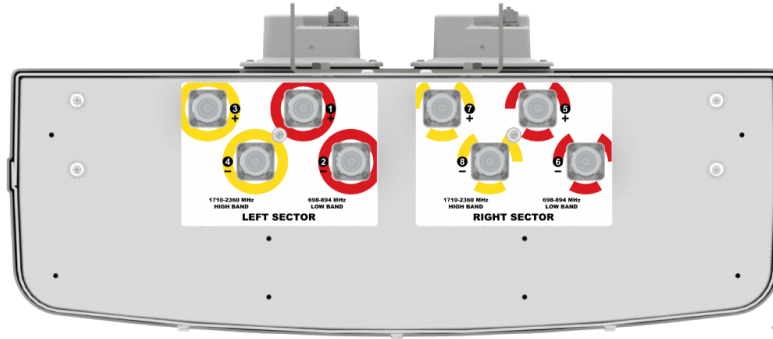

RET Diagram

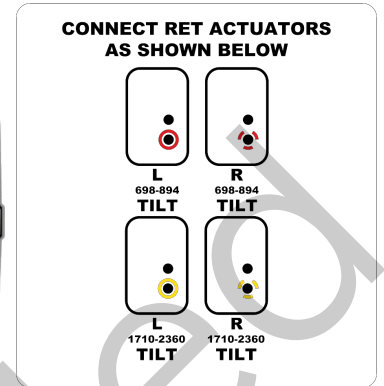

Mechanical

Connector Spacing

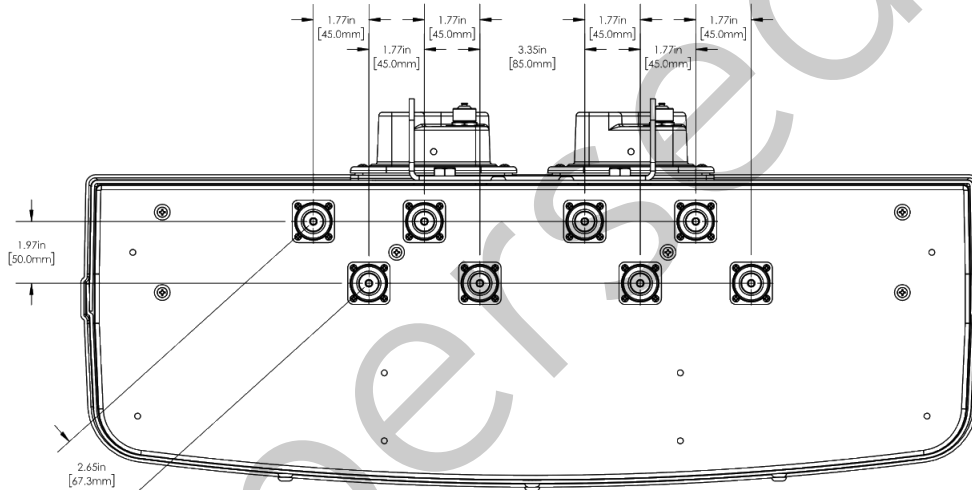



Antennas

SPECIFICATIONS

Multi-band Bi-Sector™ Array

BSA-M65R-BU-H4

Typical Antenna Patterns

For detailed information on additional antenna patterns, contact customer support at support@cciproducts.com

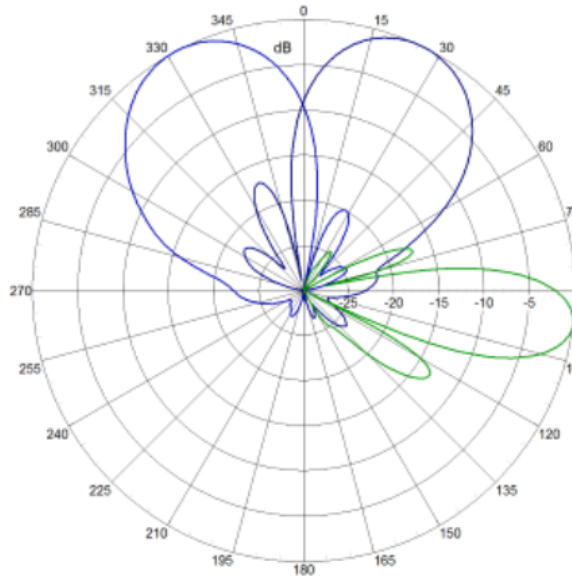

761 MHz Azimuth Elevation 7°

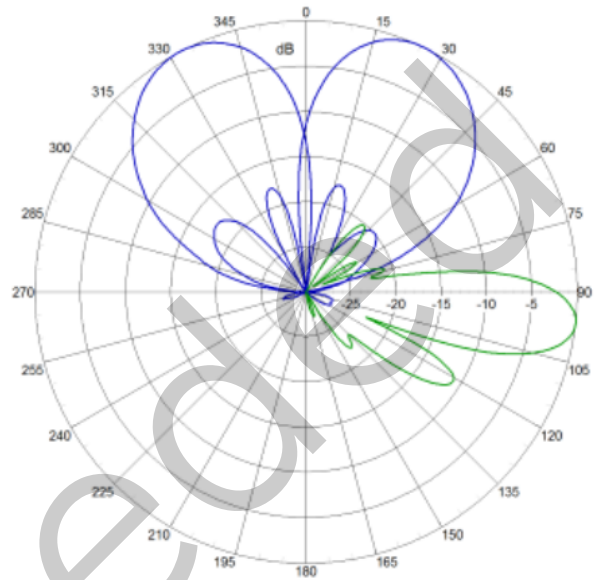

849 MHz Azimuth Elevation 7°

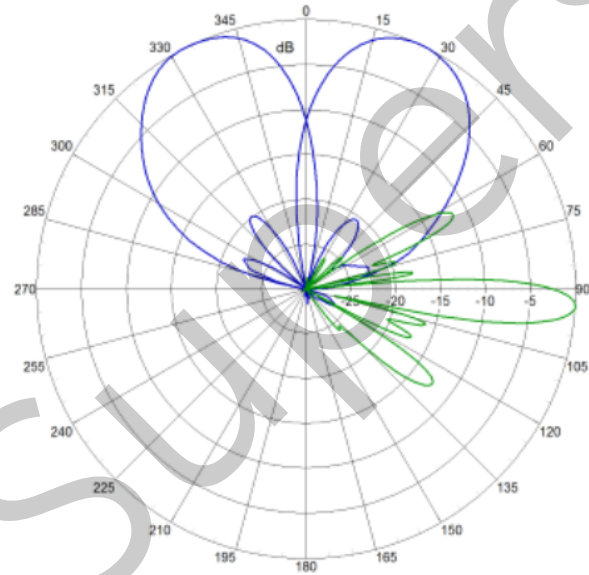

1940 MHz Azimuth Elevation 7°



Antennas

ORDERING

Multi-band Bi-Sector™ Array

BSA-M65R-BU-H4

Parts & Accessories

BSA-M65R-BU-H4	Four foot (1.3 m) Bi-Sector™ array, Multi-band Antenna and 4 factory installed BSA-RET200 RET actuators
BSA-M65R-BU-H4-K	Antenna kit with 4 factory installed RET actuators and MBK-02 mounting bracket
MBK-02	Mounting bracket kit (top and bottom) with 0° to 10° mechanical tilt adjustment
BSA-RET200	Remote electrical tilt actuator
OPA-CBK-AG-RRU	OctoPort antenna to RRU AISG cable kit
OPA-CBK-RA-AG-RRU	OctoPort antenna to RRU AISG right angle cable kit

Superseded



Antennas

ACCESSORIES

Mounting Bracket Kit

MBK-02

Mechanical

Weight	9.8 lbs (4.4 kg)
Hinge Pitch	31.5 in (800 mm)
Mounting Pole Dimension	2 to 5 in (5 to 12 cm)
Fastener Size	M10
Installation Torque	15 ft.-lbs (20 N.m)
Mechanical Tilt Adjustment	0° - 10°

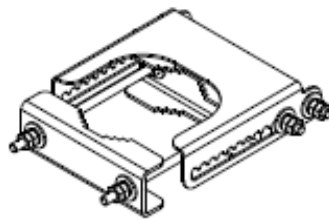

MBK-02 Top Adjustable Bracket

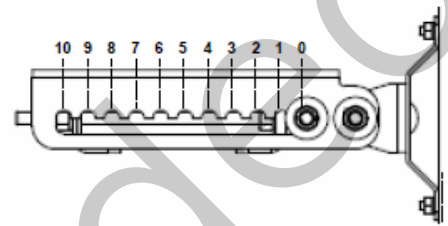

MBK-02 Top Adjustable Bracket Side View

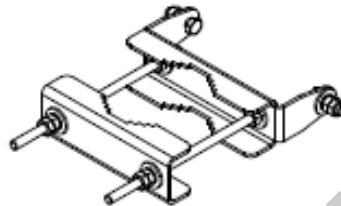

MBK-02 Bottom Fixed Bracket



Antennas

ACCESSORIES

Remote Electrical Tilt Actuator (RET)

BSA-RET200

General Specifications

Part Number	BSA-RET200
Protocols	AISG 2.0
RET Type	Type 1
Adjustment Cycles	>10,000 cycles
Tilt Accuracy	±0.1°
Temperature Range	-40° C to 70° C

Electrical

Data Interface Signal	DC
Input Voltage	10-30 Vdc
Current Consumption Tilt	120 mA at $V_{in}=24$
Current Consumption Idle	55 mA at $V_{in}=24$
Hardware Interface	AISG-RS 485 A/B
Input Connector	Male 1 × 8 pin Daisy Chain
Output Connector	Female 1 × 8 pin Daisy Chain

Mechanical

Dimensions (LxWxD)	8.0x5.0x2.0 in. (213x135x51 mm)
Housing	ASA/ABS/Aluminum
Weight	1.7 lbs (0.75 kg)

ASA= Acrylic Styrene Acrylonitrile
ABS=Acrylonitrile Butadiene Styrene

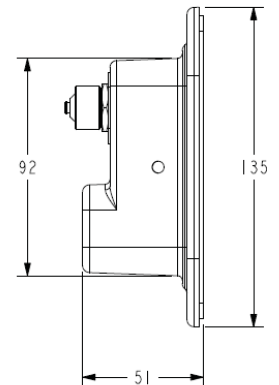
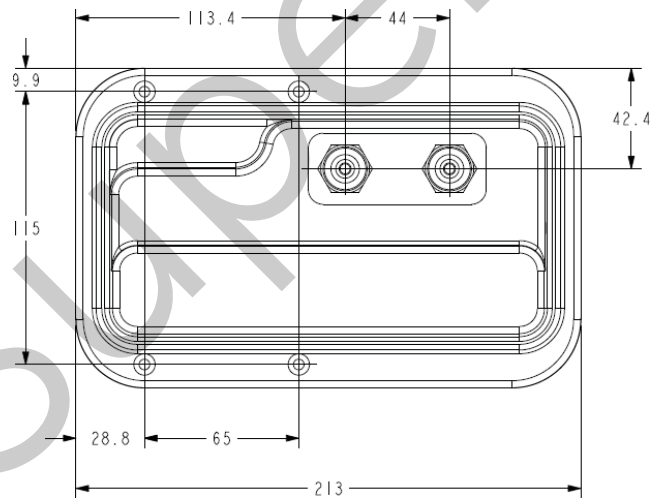



Antennas

ACCESSORIES

AISG Cable Kit

OPA-CBK-AG-RRU

Electrical Specifications

Individual Cable Part Number	AISGC-M-F-18	AISGC-M-F-10FT
Cable style	UL2464	UL2464
Protocol	AISG 1.1 and AISG 2.0	AISG 1.1 and AISG 2.0
Maximum voltage	300 V	300 V
Rated current	5 A at 104° F (40° C)	5 A at 104° F (40° C)

Mechanical Specifications

Individual Cable Part Number	AISGC-M-F-18	AISGC-M-F-10FT
Cables per kit	3	2
Connectors	2 x 8 pin IEC 60130-9 Straight male/straight female	2 x 8 pin IEC 60130-9 Straight male/straight female
Tightening torque	Hand tighten only \approx 1.84 ft-lbs (2.5 N-m)	Hand tighten only \approx 1.84 ft-lbs (2.5 N-m)
Construction	Shielded (Tinned Copper Braid)	Shielded (Tinned Copper Braid)
Braid coverage	85%	85%
Jacket Material	Matte Polyurethane (Black)	Matte Polyurethane (Black)
Conductors	1 twisted pair - 24 AWG 3 conductors - 19 AWG AWM style 2464	1 twisted pair - 24 AWG 3 conductors - 19 AWG AWM style 2464
Cable Diameter	0.307 in (7.8 mm)	0.307 in (7.8 mm)
Length	18 - 20 in (457 - 508 mm)	120 in (3048 mm)
Weight	0.27 lbs (0.12 kg)	0.69 lbs (.31 kg)
Minimum bend radius	3.9 in (100 mm)	3.9 in (100 mm)

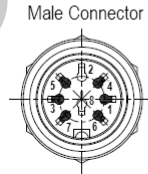
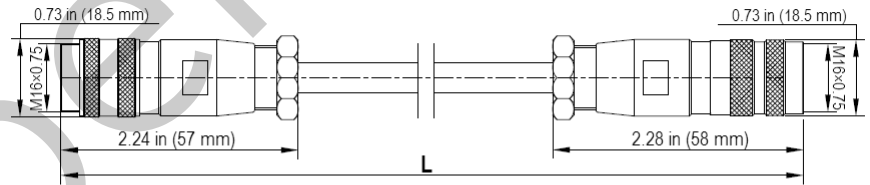

AISG 2.0 Pin Assignments	AISG Standard
1	+12 V DC nominal (optional)
2	No conductor
3	RS485 B
4	No conductor
5	RS485 A
6	10 - 30 V DC
7	DC Return (not DC power ground)
8	No conductor

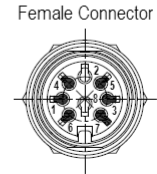

AISG-Male to AISG-Female Jumper Cable

Environmental Specifications

Individual Cable Part Number	AISGC-M-F-18	AISGC-M-F-10FT
Temperature Range	-40° to 80° C	-40° to 80° C
Flammability	UL 1581 VW-1	UL 1581 VW-1
Ingress Protection	IEC 60529:2001, IP67	IEC 60529:2001, IP67



Antennas

ACCESSORIES

AISG Cable Kit

OPA-CBK-RA-AG-RRU

Electrical Specifications

Individual Cable Part Number	AISGC-MRA-FRA-20	AISGC-M-FRA-10FT
Cable style	UL2464	UL2464
Protocol	AISG 1.1 and AISG 2.0	AISG 1.1 and AISG 2.0
Maximum voltage	300 V	300 V
Rated current	5 A at 104° F (40° C)	5 A at 104° F (40° C)

Mechanical Specifications

Individual Cable Part Number	AISGC-MRA-FRA-20	AISGC-M-FRA-10FT
Cables per kit	3	2
Connectors	2 x 8 pin IEC 60130-9 Right angle male/right angle female	2 x 8 pin IEC 60130-9 Straight male/right angle female
Tightening torque	Hand tighten only ≈ 1.84 ft-lbs (2.5 N-m)	Hand tighten only ≈ 1.84 ft-lbs (2.5 N-m)
Construction	Shielded (Tinned Copper Braid)	Shielded (Tinned Copper Braid)
Braid coverage	85%	85%
Jacket Material	Matte Polyurethane (Black)	Matte Polyurethane (Black)
Conductors	1 twisted pair - 24 AWG 3 conductors - 19 AWG AWM style 2464	1 twisted pair - 24 AWG 3 conductors - 19 AWG AWM style 2464
Cable Diameter	0.307 in (7.8 mm)	0.307 in (7.8 mm)
Length	20 in (508 mm)	120 in (3048 mm)
Weight	0.23 lbs (0.10 kg)	0.77 lbs (0.35 kg)
Minimum bend radius	3.9 in (100 mm)	3.9 in (100 mm)

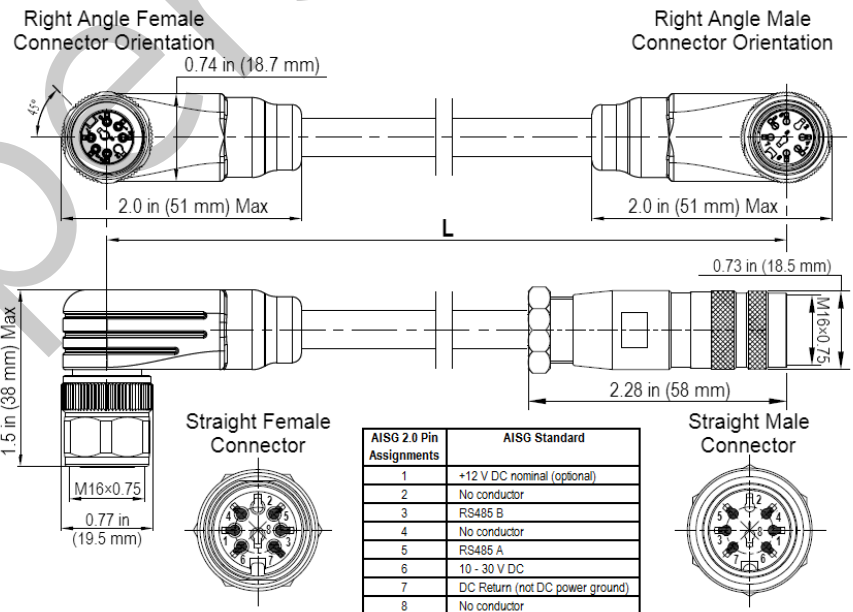

Right Angle to Right Angle and Right Angle to Straight Jumper Cable



Antennas

ACCESSORIES

AISG Cable Kit

OPA-CBK-RA-AG-RRU

Environmental Specifications

Individual Cable Part Number	AISGC-MRA-FRA-20	AISGC-M-FRA-10FT
Temperature Range	-40° to 80° C	-40° to 80° C
Flammability	UL 1581 VW-1	UL 1581 VW-1
Ingress Protection	IEC 60529:2001, IP67	IEC 60529:2001, IP67

Superseded



Antennas

STANDARDS & CERTIFICATIONS

Multi-band Bi-Sector™ Array

BSA-M65R-BU-H4

Standards & Compliance

Safety	EN 60950-1, UL 60950-1
Emission	EN 55022
Immunity	EN 55024
Environmental	IEC 60068-2-1, IEC 60068-2-2, IEC 60068-2-5, IEC 60068-2-6, IEC-60068-2-11, IEC 60068-2-14, IEC 60068-2-18, IEC 60068-2-27, IEC 60068-2-29, IEC 60068-02-30, IEC 60068-2-52, IEC 60068-2-64, GR-63-CORE 4.3.1, EN 60529, IP 24

Certifications

Antenna Interface Standards Group (AISG), Federal Communication Commission (FCC) Part 15 Class B, CE, CSA US, ISO 9001



CCI Communication Components Inc.
EXTENDING WIRELESS PERFORMANCE